

Transformator EI 30/5 0,5 VA

- Frequenz / Frequency 50/60 Hz
- Vakuumvergossen / Potted under vacuum
- Zweikammer-Wicklung / Split-bobbin
- Temperaturklasse / Temperature class ta 70°C/F
- Kurzschlußfest / Short-circuit-proof
- Gewicht / Weight 0,043kg
- Weitere Primär- und Sekundärspannungen auf Anfrage / Other primary and secondary voltages on request
- DIN EN 60335-1 Glühdrahtprüfung / glow wire test



Primär (V) Primary (V)	Sekundär (V) Secondary (V)	mA mA	Leerlaufspannung (V) No-Load Voltage (V)	Schema-Nr. Schematic-No.	Sachnummer Part.-No.	Approbationen Approvals
115	6	83,33	10,40	1	03-0014-10	1/2/3/4
115	7,5	66,67	13,35	1	03-0015-10	1/2/3/4
115	9	55,56	16,00	1	03-0016-10	1/2/3/4
115	12	41,67	21,34	1	03-0017-10	1/2/3/4
115	15	33,33	26,20	1	03-0018-10	1/2/3/4
115	18	27,78	30,28	1	03-0019-10	1/2/3/4
115	21	23,81	34,70	1	03-0020-10	1/2/3/4
115	24	20,83	39,00	1	03-0021-10	1/2/3/4
115	2x6	41,67	2 x 11,24	2	03-0022-10	1/2/3/4
115	2x7,5	33,33	2 x 13,74	2	03-0023-10	1/2/3/4
115	2x9	27,78	2 x 16,00	2	03-0024-10	1/2/3/4
115	2x12	20,83	2 x 20,40	2	03-0025-10	1/2/3/4
115	2x15	16,66	2 x 24,92	2	03-0026-10	1/2/3/4

Technische Änderungen vorbehalten!

Mechanische Abmessungen/Mechanical

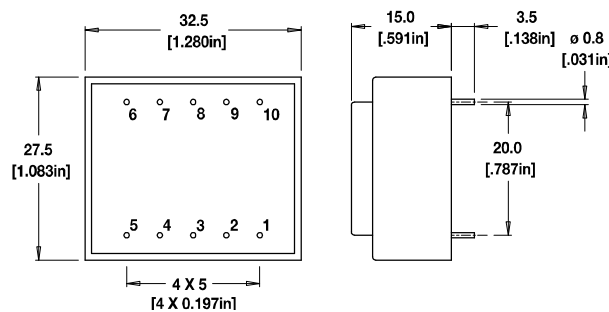

Schema/Schematics

No. 1

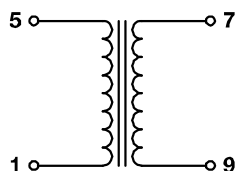

No. 2

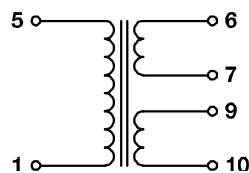

No. 3

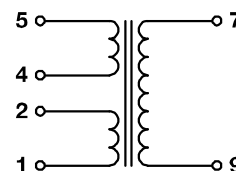

No. 4

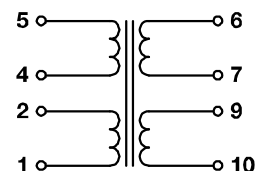

Approbationen/Approvals



1.



2.



3.



4.

Transformator EI 30/5 0,5 VA

- Frequenz / Frequency 50/60 Hz
- Vakuumvergossen / Potted under vacuum
- Zweikammer-Wicklung / Split-bobbin
- Temperaturklasse / Temperature class ta 70°C/F
- Kurzschlußfest / Short-circuit-proof
- Gewicht / Weight 0,043kg
- Weitere Primär- und Sekundärspannungen auf Anfrage / Other primary and secondary voltages on request
- DIN EN 60335-1 Glühdrahtprüfung / glow wire test



Primär (V) Primary (V)	Sekundär (V) Secondary (V)	mA mA	Leerlaufspannung (V) No-Load Voltage (V)	Schema-Nr. Schematic-No.	Sachnummer Part.-No.	Approbationen Approvals
230	6	83,33	10,40	1	03-0001-10	1/2/3/4
230	7,5	66,67	13,35	1	03-0002-10	1/2/3/4
230	9	55,56	16,00	1	03-0003-10	1/2/3/4
230	12	41,67	21,34	1	03-0004-10	1/2/3/4
230	15	33,33	26,20	1	03-0005-10	1/2/3/4
230	18	27,78	30,28	1	03-0006-10	1/2/3/4
230	21	23,81	34,70	1	03-0007-10	1/2/3/4
230	24	20,83	39,00	1	03-0008-10	1/2/3/4
230	2x6	41,67	2 x 11,24	2	03-0009-10	1/2/3/4
230	2x7,5	33,33	2 x 13,74	2	03-0010-10	1/2/3/4
230	2x9	27,78	2 x 16,00	2	03-0011-10	1/2/3/4
230	2x12	20,83	2 x 20,40	2	03-0012-10	1/2/3/4
230	2x15	16,66	2 x 24,92	2	03-0013-10	1/2/3/4

Technische Änderungen vorbehalten!

Mechanische Abmessungen/Mechanical

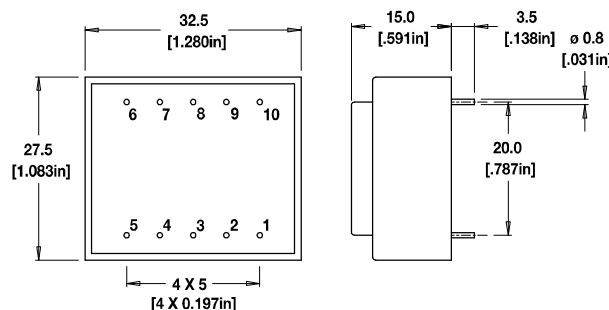

Schema/Schematics

No. 1

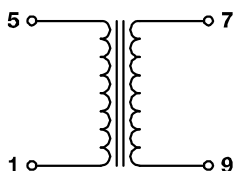

No. 2

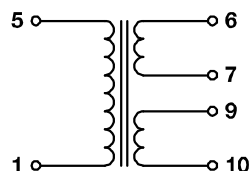

No. 3

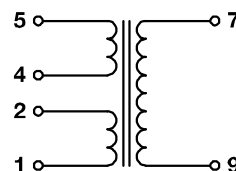

No. 4

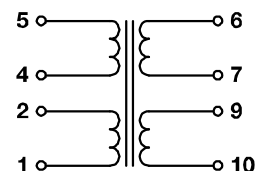

Approbationen/Approvals



1.



2.



3.



4.

Transformator EI 30/5 0,5 VA

- Frequenz / Frequency 50/60 Hz
- Vakuumvergossen / Potted under vacuum
- Zweikammer-Wicklung / Split-bobbin
- Temperaturklasse / Temperature class ta 70°C/F
- Kurzschlußfest / Short-circuit-proof
- Gewicht / Weight 0,043kg
- Weitere Primär- und Sekundärspannungen auf Anfrage / Other primary and secondary voltages on request
- DIN EN 60335-1 Glühdrahtprüfung / glow wire test



Primär (V) Primary (V)	Sekundär (V) Secondary (V)	mA mA	Leerlaufspannung (V) No-Load Voltage (V)	Schema-Nr. Schematic-No.	Sachnummer Part.-No.	Approbationen Approvals
2x115	6	83,33	10,40	3	03-0027-10	1/2/3/4
2x115	7,5	66,67	13,35	3	03-0028-10	1/2/3/4
2x115	9	55,56	16,00	3	03-0029-10	1/2/3/4
2x115	12	41,67	21,34	3	03-0030-10	1/2/3/4
2x115	15	33,33	26,20	3	03-0031-10	1/2/3/4
2x115	18	27,78	30,28	3	03-0032-10	1/2/3/4
2x115	21	23,81	34,70	3	03-0033-10	1/2/3/4
2x115	24	20,83	39,00	3	03-0034-10	1/2/3/4
2x115	2x6	41,67	2x11,24	4	03-0035-10	1/2/3/4
2x115	2x7,5	33,33	2x13,74	4	03-0036-10	1/2/3/4
2x115	2x9	27,78	2x16,00	4	03-0037-10	1/2/3/4
2x115	2x12	20,83	2x20,40	4	03-0038-10	1/2/3/4
2x115	2x15	16,66	2x24,92	4	03-0039-10	1/2/3/4

Technische Änderungen vorbehalten!

Mechanische Abmessungen/Mechanical

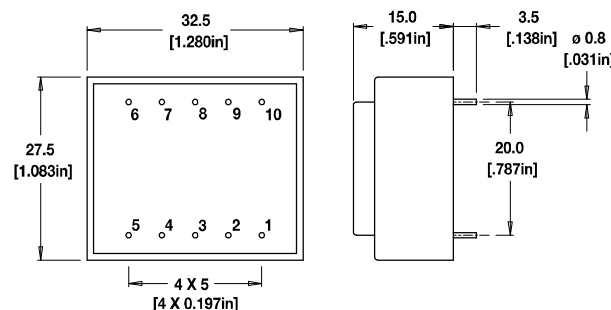

Schema/Schematics

No. 1

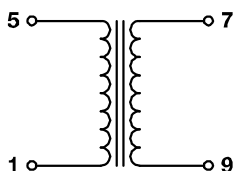

No. 2

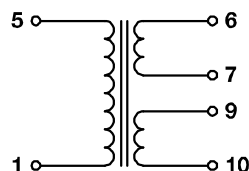

No. 3

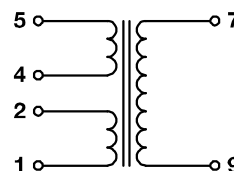

No. 4

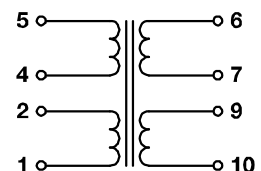

Approbationen/Approvals



1.



2.



3.



4.